

## ■ BRACCIO QUADRO CON DEVIATORE

Braccio con attacco a muro da 1/2" in **ottone** cromato con **DEVIATORE** integrato.

*Chromed **brass** shower arm with wall connection 1/2" integrated **DIVERTER**.*

*Bras de douche en **laiton** chromé avec connexion 1/2" à paroi et **INVERSEUR** intégré.*

*Wandarm aus **Messing** 1/2" mit integriertem **UMSTELLER**.*

*Brazo de pared de **latón** con conexión 1/2" y **DEVIASDOR**.*

*Настенный латунный кронштейн с переключателем и подключением 1/2.*



**06000CR35**

30x10 mm 350 mm

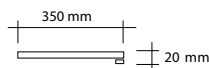

## ■ BRACCIO QUADRO CON DEVIATORE + BORA

Kit braccio quadro con deviatore e soffione BORA, con flessibile SILVER EXTRA, supporto e doccia CUBE.

*Shower arm with diverter + Shower head BORA + Shower kit (CUBE, SILVER EXTRA, shower holder).*

*Bras de douche + Pomme de douche BORA + Kit douchette (CUBE, SILVER EXTRA, porte-douchette).*

*Wandarm + Kopfbrause BORA + Handbrause Kit (CUBE, SILVER EXTRA, Brausehalter).*

*Brazo + Rociador BORA + Kit de mango ducha (CUBE, SILVER EXTRA, soporte).*

*Кронштейн + Верхий душ BORA + Душевой набор (CUBE, SILVER EXTRA, держатель для душа).*



**KIT060BO**

200x200 mm



## ■ BRACCIO QUADRO CON DEVIATORE + NETTUNO

Kit braccio quadro con deviatore e soffione NETTUNO, con flessibile SILVER EXTRA, supporto e doccia CUBE.

*Shower arm with diverter + Shower head NETTUNO + Shower kit (CUBE, SILVER EXTRA, shower holder).*

*Bras de douche + Pomme de douche NETTUNO + Kit douchette (CUBE, SILVER EXTRA, porte-douchette).*

*Wandarm + Kopfbrause NETTUNO + Handbrause Kit (CUBE, SILVER EXTRA, Brausehalter).*

*Brazo + Rociador NETTUNO + Kit de mango ducha (CUBE, SILVER EXTRA, soporte).*

*Кронштейн + Верхий душ NETTUNO + Душевой набор (CUBE, SILVER EXTRA, держатель для душа).*



**KIT060NE**

200x200 mm



## ● BRACCIO LUX CON DEVIATORE

Braccio con attacco a muro da 1/2" in **ottone** cromato con **DEVIATORE** integrato.

*Chromed **brass** shower arm with wall connection 1/2" integrated **DIVERTER**.*

*Bras de douche en **laiton** chromé avec connexion 1/2" à paroi et **INVERSEUR** intégré.*

*Wandarm aus **Messing** 1/2" mit integriertem **UMSTELLER**.*

*Brazo de pared de **laton** con conexión 1/2" y **DEVIASDOR**.*

*Настенный латунный кронштейн с переключателем и подключением 1/2.*



Entrata acqua.  
Water connection.

**05950CR35**

Ø 21 mm

350 mm



## ● BRACCIO LUX CON DEVIATORE + SCIROCCO

Kit braccio LUX tondo con deviatore e soffione **SCIROCCO** in **ABS**, con flessibile **SILVER EXTRA**, supporto e doccia **STICK**.

*Shower arm with diverter + Shower head **SCIROCCO** + Shower kit (**STICK**, **SILVER EXTRA**, shower holder).*

*Bras de douche + Pomme de douche **SCIROCCO** + Kit douchette (**STICK**, **SILVE EXTRA**, porte-douchette).*

*Wandarm + Kopfbrause **SCIROCCO** + Handbrause Kit (**STICK**, **SILVER EXTRA**, Brausehalter).*

*Brazo + Rociador **SCIROCCO** + Kit de mango ducha (**STICK**, **SILVER EXTRA**, soporte).*

*Кронштейн + Верхий душ **SCIROCCO** + Душевой набор (**STICK**, **SILVER EXTRA**, держатель для душа).*



**KIT059SCI**

Ø 200 mm



## ● BRACCIO LUX CON DEVIATORE + DELTA

Kit braccio LUX tondo con deviatore e soffione **DELTA**, con flessibile **SILVER EXTRA**, supporto e doccia **STICK**.

*Shower arm with diverter + shower head **DELTA** + shower kit (**STICK**, **SILVER EXTRA**, shower holder).*

*Bras de douche + pomme de douche **DELTA** + kit douchette (**STICK**, **SILVE EXTRA**, porte-douchette).*

*Wandarm + Kopfbrause **DELTA** + Handbrause Kit (**STICK**, **SILVER EXTRA**, Brausehalter).*

*Brazo + rociador **DELTA** + kit de mango ducha (**STICK**, **SILVER EXTRA**, soporte).*

*Кронштейн + Верхий душ **DELTA** + Душевой набор (**STICK**, **SILVER EXTRA**, держатель для душа).*



**KIT059DE**

Ø 200 mm



## BIG

Braccio con attacco a muro da 1/2" Ø 28 mm in **ottone** cromato. Con rosone Ø 90 mm regolabile.

*Chromed brass shower arm Ø 28 mm with wall connection 1/2" and adjustable rosette.*

*Bras de douche en laiton chromé Ø 28 mm avec connexion à paroi 1/2" et rosace réglable.*

*Wandarm aus Messing Ø 28 mm mit Wandanschluss 1/2" und verstellbare Wandrosette.*

*Brazo de pared de latón Ø 28 mm con conexión 1/2" y roseton ajustable.*

*Латунный кронштейн Ø 28 мм с подключением 1/2" и регулируемой розеткой.*

**05970CR35**    Ø 28 mm    L=350 mm

**05970CR45**    Ø 28 mm    L=450 mm

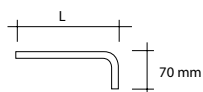

## LARGE

Braccio con attacco a muro da 1/2" Ø 26 mm in **ottone** cromato.

*Chromed brass shower arm Ø 26 mm with wall connection 1/2".*

*Bras de douche en laiton chromé Ø 26 mm avec connexion à paroi 1/2".*

*Wandarm aus Messing Ø 26 mm mit Wandanschluss 1/2".*

*Brazo de pared de latón Ø 26 mm con conexión 1/2".*

*Латунный кронштейн Ø 26 мм с подключением 1/2".*

**05926CR35**    Ø 26 mm    L=350 mm

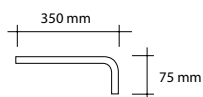

## INOX

Braccio con attacco a muro da 1/2"  
in **acciaio INOX** Ø 23 mm spessore 1,5 mm.

**Stainless steel** shower arm Ø 23 mm,  
thickness 1,5 mm with wall connection 1/2".

Bras de douche en **acier inox** Ø 23 mm,  
épaisseur 1,5 mm avec connexion à paroi 1/2".

Wandarm aus **Edelstahl** Ø 23 mm,  
Dicke 1,5 mm mit Wandanschluss 1/2".

Brazo de pared de **acero** Ø 23 mm,  
espesor 1,5 mm con conexión 1/2".

Кронштейн из нержавеющей стали Ø 23 мм,  
толщиной 1,5 мм с подключением 1/2".

<b>05930IN30</b>	Ø 23 mm	L=300 mm
<b>05930IN35</b>	Ø 23 mm	L=350 mm
<b>05930IN40</b>	Ø 23 mm	L=400 mm

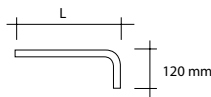

## INOX MIDI

Braccio con attacco a muro da 1/2"  
in **acciaio INOX** Ø 22 mm spessore 1 mm.

**Stainless steel** shower arm Ø 22 mm,  
thickness 1 mm with wall connection 1/2".

Bras de douche en **acier inox** Ø 22 mm,  
épaisseur 1 mm avec connexion à paroi 1/2".

Wandarm aus **Edelstahl** Ø 22 mm,  
Dicke 1 mm mit Wandanschluss 1/2".

Brazo de pared de **acero** Ø 22 mm,  
espesor 1 mm con conexión 1/2".

Кронштейн из нержавеющей стали Ø 22 мм,  
толщиной 1 мм с подключением 1/2".

<b>05930IN30MIDI</b>	Ø 22 mm	L=300 mm
<b>05930IN35MIDI</b>	Ø 22 mm	L=350 mm
<b>05930IN40MIDI</b>	Ø 22 mm	L=400 mm

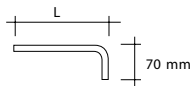

## TONDO MINIMAL

Braccio con attacco a muro da 1/2"  
in **ottone cromato** Ø 20 mm. Con rosone regolabile.

**Chromed brass** shower arm Ø 20 mm  
with wall connection 1/2" and adjustable rosette.

Bras de douche en **laiton chromé** Ø 20 mm  
avec connexion à paroi 1/2" et rosace réglable.

Wandarm aus **Messing** Ø 20 mm  
mit Wandanschluss 1/2" und verstellbare Wandrosette.

Brazo de pared de **latón** Ø 20 mm  
con conexión 1/2" y roseton ajustable.

Латунный кронштейн Ø 20 мм  
с подключением 1/2" и регулируемой розеткой.

<b>05940CR30</b>	Ø 20 mm	L=300 mm
<b>05940CR35</b>	Ø 20 mm	L=350 mm

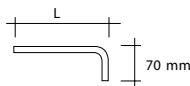

## LUX

Braccio con attacco a muro da 1/2" in **ottone** cromato Ø 21 mm. Con rosone regolabile.

Chromed **brass** shower arm Ø 21 mm with wall connection 1/2" and adjustable rosette.

Bras de douche en **laiton** chromé Ø 21 mm a avec connexion à paroi 1/2" et rosace réglable.

Wandarm aus **Messing** Ø 21 mm mit Wandanschluss 1/2" und verstellbare Wandrosette.

Brazo de pared de **latón** Ø 21 mm con conexión 1/2" y roseton ajustable.

Латунный кронштейн Ø 21 мм с подключением 1/2" и регулируемой розеткой.

**05910CR30** Ø 21 mm L=300 mm

**05910CR35** Ø 21 mm L=350 mm

**05910OR35** Ø 21 mm L=350 mm

**05910VR35** Ø 21 mm L=350 mm

**05910VO35** Ø 21 mm L=350 mm

**05910CR40** Ø 21 mm L=400 mm

Entrata acqua.  
Water connection.

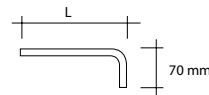
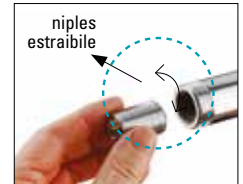

## LUX ESTERNO

Braccio con attacco esterno da 1/2" in **ottone** cromato Ø 18 mm.

Chromed **brass** shower arm Ø 18 mm with external water inlet 1/2".

Bras de douche en **laiton** chromé Ø 18 mm avec entrée externe de l'eau 1/2".

Wandarm aus **Messing** Ø 18 mm mit Außenwasseranschluss 1/2".

Brazo de **latón** Ø 18 mm con entrada de agua externa 1/2".

Латунный кронштейн Ø 18 мм с наружной подводкой 1/2".

**05900CR35** Ø 18 mm L=350 mm

Fissaggio a muro.  
Wall bracket.



Entrata acqua.  
Water connection.

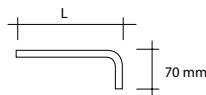

## SOFFITTO TONDO

Braccio con attacco a soffitto da 1/2" in **ottone** cromato Ø 21 mm.

Chromed **brass** shower arm Ø 21 mm with ceiling connection 1/2".

Bras de douche en **laiton** chromé Ø 21 mm avec connexion 1/2" à plafond.

Decke Duscharm aus **Messing** Ø 21 mm mit anschluss 1/2".

Brazo de techo de **latón** Ø 21 mm con conexión 1/2".

Потолочный латунный кронштейн Ø 21 мм с подключением 1/2".

**05960CR10/20** Ø 21 mm L=100 mm

**05960CR30** Ø 21 mm L=300 mm

**05960CR40** Ø 21 mm L=400 mm

Entrata acqua.  
Water connection.

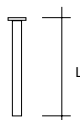
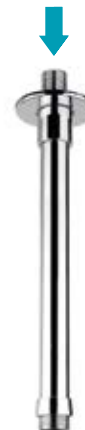

## RETTANGOLARE

Braccio con attacco a muro da 1/2"  
in **ottone** cromato  $\square$  30x10 mm.

*Chromed **brass** shower arm  $\square$  30x10 mm  
with wall connection 1/2".*

*Bras de douche en **laiton** chromé  $\square$  30x10 mm  
avec connexion à paroi 1/2".*

*Wandarm aus **Messing**  $\square$  30x10 mm  
mit Wandanschluss 1/2".*

*Brazo de pared de **latón**  $\square$  30x10 mm con conexión 1/2".*

*Латунный кронштейн  $\square$  30x10 мм  
с подключением 1/2"*

**06010CR40/35**  $\square$  30x10 mm L=400 mm

Entrata acqua.  
Water connection.

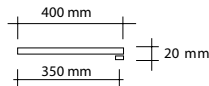

## QUADRO MINIMAL

Braccio con attacco a muro da 1/2"  
in **ottone** cromato  $\square$  22x22 mm.

*Chromed **brass** shower arm  $\square$  22x22 mm  
with wall connection 1/2".*

*Bras de douche en **laiton** chromé  $\square$  22x22 mm  
avec connexion à paroi 1/2".*

*Wandarm aus **Messing**  $\square$  22x22 mm  
mit Wandanschluss 1/2".*

*Brazo de pared de **latón**  $\square$  22x22 mm con conexión 1/2".*

*Латунный кронштейн  $\square$  22x22 мм  
с подключением 1/2"*

**05995CR35**  $\square$  22x22 mm L=350 mm

Entrata acqua.  
Water connection.

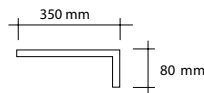

## ARMONIA

Braccio in **ottone** cromato  $\square$  22x22 mm  
spessore 1,5 mm con attacco a muro da 1/2".

*Chromed **brass** shower arm  $\square$  22x22 mm,  
thickness 1,5 mm with wall connection 1/2".*

*Bras de douche en **laiton** chromé  $\square$  22x22 mm,  
épaisseur 1,5 mm, avec connexion à paroi 1/2".*

*Wandarm aus **Messing**  $\square$  22x22 mm,  
Dicke 1,5 mm, mit Wandanschluss 1/2".*

*Brazo de pared de **latón**  $\square$  22x22 mm,  
espesor 1,5 mm, conexión 1/2".*

*Латунный кронштейн  $\square$  22x22 мм  
(толщиной 1,5 мм) с подключением 1/2"*

**05999CR35**  $\square$  22x22 mm L=350 mm

Entrata acqua.  
Water connection.

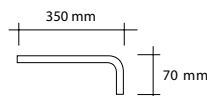

## SOFFITTO QUADRO

Braccio con attacco a soffitto da 1/2"  
in **ottone** cromato 30x30 mm.

*Chromed **brass** shower arm 30x30 mm  
with ceiling connection 1/2".*

*Bras de douche en **laiton** chromé 30x30 mm  
avec connexion 1/2" à plafond.*

*Decke Duscharm aus **Messing** 30x30 mm  
mit anschluss 1/2".*

*Brazo de techo de **latón** 30x30 mm con conexión 1/2"*

*Потолочный латунный кронштейн 30x30 мм с  
подключением 1/2".*

**05965CR10** 30x30 mm L=100 mm

**05965CR20** 30x30 mm L=200 mm

**05965CR30** 30x30 mm L=300 mm

**05965CR40** 30x30 mm L=400 mm



Entrata acqua.  
Water connection.



## ECO

Braccio con attacco a muro da 1/2" F  
in **metallo** cromato.

*Chromed **metal** shower arm with wall connection 1/2".*

*Bras de douche en **metal** chromé  
avec connexion à paroi 1/2".*

*Wandarm aus **Metall** mit Wandanschluss 1/2".*

*Brazo de pared de **metal** con conexión 1/2".*

*Металлический кронштейн с подключением 1/2".*

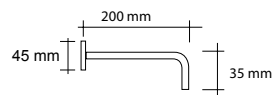

**04210CR** L=200 mm



## STANDARD

Braccio con attacco a muro da 1/2"  
in **ottone** cromato Ø 18 mm.

*Chromed **brass** shower arm Ø 18 mm  
with wall connection 1/2".*

*Bras de douche en **laiton** chromé Ø 18 mm  
avec connexion à paroi 1/2".*

*Wandarm aus **Messing** Ø 18 mm mit Wandanschluss 1/2".*

*Brazo de pared de **latón** Ø 18 mm con conexión 1/2".*

*Латунный кронштейн Ø 18 мм с подключением 1/2".*

**04220CR20** Ø 18 mm L=200 mm

**04220CR30** Ø 18 mm L=300 mm

**04220CR35** Ø 18 mm L=350 mm

**04220CR40** Ø 18 mm L=400 mm

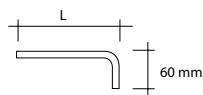

## ● ORIZZONTE

Braccio con attacco a muro da 1/2" in **ottone** cromato Ø 18 mm con presa acqua a 2 uscite. Altezza totale 35 cm  
*Chromed brass shower arm Ø 18 mm with 1 inlet and 2 outlets with diverter. Total height 35 cm, possibility to adjust.*

*Bras de douche en laiton chromé Ø 18 mm avec une entrée de l'eau, deux sorties et un inverseur. Hauteur totale 35 cm, possibilité de la modifier.*

*Wandarm aus Messing Ø18 mm mit 1 Eingang und 2 Ausgänge mit Umsteller. Gesamtgröße 35 cm kürzbare.*

*Brazo de pared de latón Ø 18 mm con 1 entrada y 2 salidas con devisador. Altura total 35 cm, posibilidad de cortar.*

*Латунный кронштейн Ø 18 мм с переключателем. Высота 35 см, которая может быть укороченной.*

05988CR

Ø 18 mm

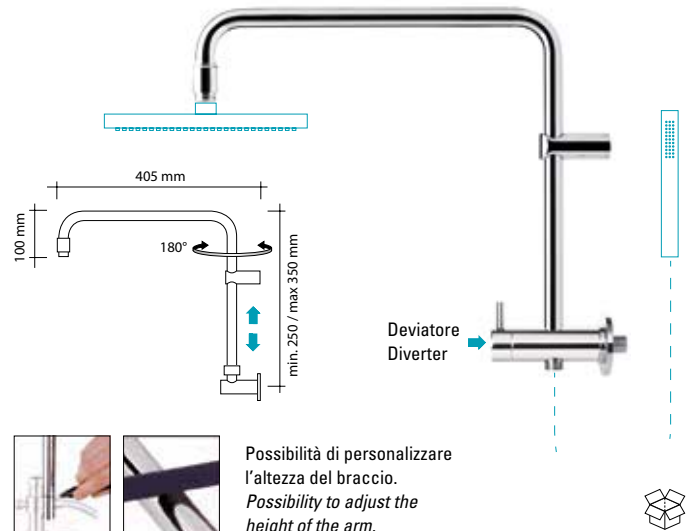

## ● PARADISO

Braccio con attacco a muro da 1/2" in **ottone** cromato Ø 18 mm. Altezza totale 35 cm

*Chromed brass shower arm Ø 18 mm with wall connection 1/2", total height 35 cm. Possibility to adjust the height of the arm.*

*Bras de douche en laiton chromé Ø 18 mm avec connexion 1/2" à paroi. Hauteur totale 35 cm et possibilité de la modifier.*

*Wandarm aus Messing Ø 18 mm mit Wandanschluss 1/2". Gesamtgröße 35 cm kürzbare.*

*Brazo de pared de latón Ø 18 mm con conexión 1/2". Altura total 50 cm, posibilidad de cortar.*

*Латунный кронштейн Ø 18 мм с подключением 1/2". Высота 35 см, которая может быть укороченной.*

05936CR

Ø 18 mm

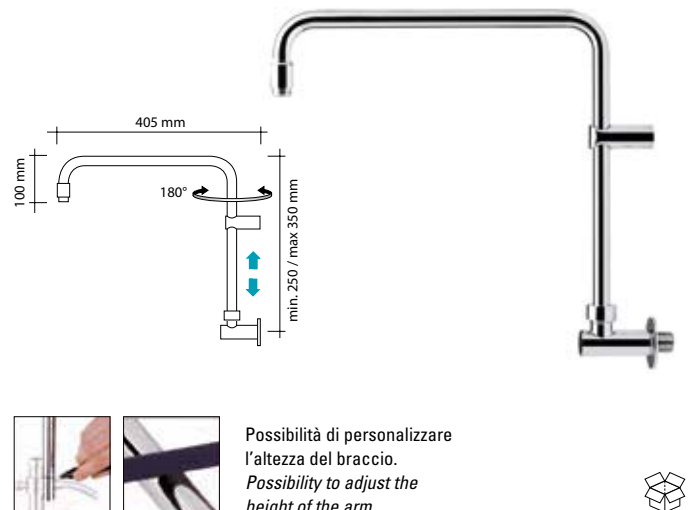

## ● ARCOBALENO

Braccio con attacco a muro da 1/2" in **ottone** cromato Ø 18 mm. Altezza totale 50 cm

*Chromed brass shower arm Ø 18 mm with wall connection 1/2", total height 50 cm. Possibility to adjust the height of the arm.*

*Bras de douche en laiton chromé Ø 18 mm avec connexion 1/2" à paroi. Hauteur totale 50 cm et possibilité de la modifier.*

*Wandarm aus Messing Ø 18 mm mit Wandanschluss 1/2". Gesamtgröße 50 cm kürzbare.*

*Brazo de pared de latón Ø 18 mm con conexión 1/2". Altura total 50 cm, posibilidad de cortar.*

*Латунный кронштейн Ø 18 мм с подключением 1/2". Высота 50 см, которая может быть укороченной*

05980CR

Ø 18 mm

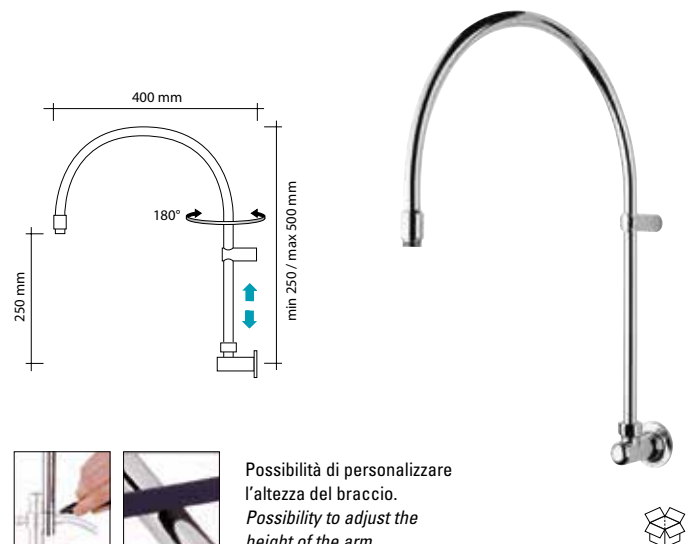



## ● MEMBRANA TONDA

Membrana per SCIROCCO, DELTA.

*Membrane for SCIROCCO, DELTA.*



**ME05650**

---

## ■ MEMBRANA QUADRA

Membrana per BORA, NETTUNO, OMEGA, EROS.

*Membrane for BORA, NETTUNO, OMEGA, EROS.*

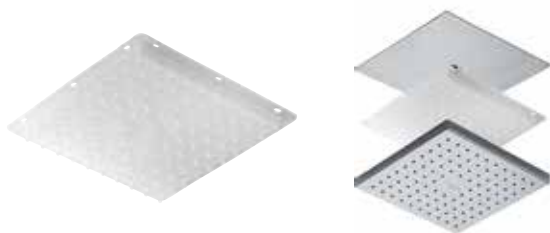

**ME05632**

---



Kit braccio LUX + soffione DELTA  
*Kit LUX arm + Shower-head DELTA*

**K0595350CR**

Kit braccio LUX + soffione SCIROCCO

**K0595650CR**

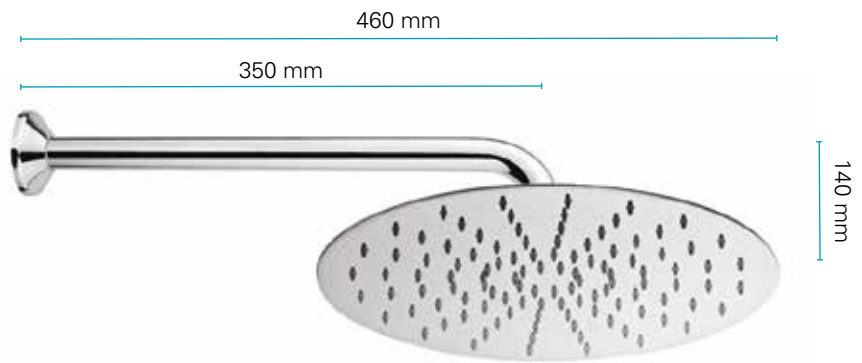

Kit braccio INOX + soffione PULSAR  
Ø 200 mm - aggraffato  
*Kit INOX Arm + Shower-head PULSAR  
diameter 200 mm- crimped*

**K0571NAG205**



Kit braccio MINIMAL TONDO + soffione  
PENELOPE Ø 200 mm - 5 mm  
*Kit MINIMAL TONDO Arm + Shower-head  
PENELOPE - diameter 200mm - 5 mm*

**K0595330CR**

Kit braccio MINIMAL QUADRO + soffione  
NETTUNO  
*Kit MINIMAL QUADRO Arm + Shower-head  
NETTUNO*

**K059700CR**

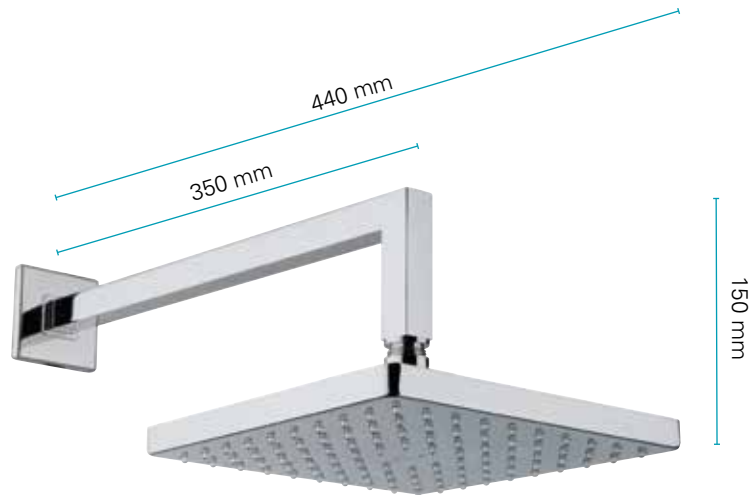

Kit braccio MINIMAL QUADRO + soffione BORA

**K0595632CR**

Kit braccio INOX + soffione QUASAR  
200x200 mm - aggraffato  
*Kit INOX arm + Head-shower QUASAR  
200x200 mm - crimped*

**K057INAG200Q**



Kit braccio MINIMAL QUADRO + soffione  
PERICLE 200x200 mm - 5 mm  
*Kit MINIMAL QUADRO arm + Shower head  
PERICLE 200x200 mm - 5 mm*

**K0595730CR**

